

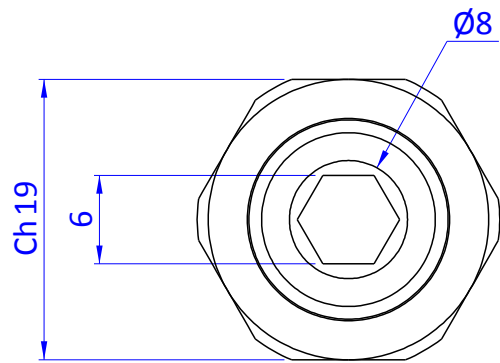

THE PROPERTY OF THE DRAWING IS ESTABLISHED BY LAW. IT IS FORBIDDEN TO PRODUCE OR SHOW IT TO THIRD PART. WITHOUT A WRITTEN AGREEMENT.

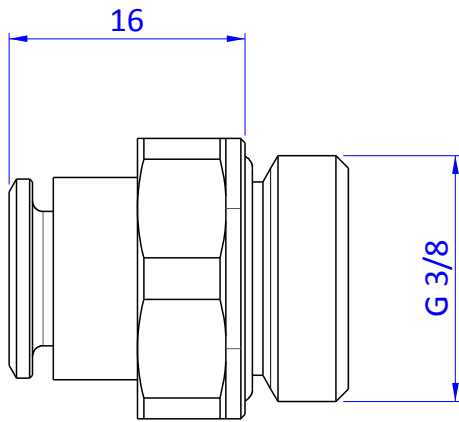
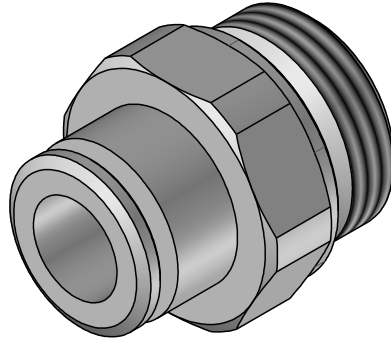
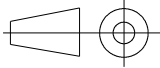

Format A4 UNI 936-76				DESIGNED FROM FPS Automation		REVIEW A
	GENERAL TOLERANCE UNI - ISO 2768 CLASSE f			DATE 06/08/2016		WEIGHT 0.027Kg
	DESCRIPTION CA.12.05.049			CODE CA.12.05.049		